



# **PB19H01.0**

## **Product Specification**

## Approval Sheet

PB19H01.0 Product Specification

RoHS

<b>Product</b>	COB
<b>Model Name</b>	PB19H01.0
<b>Issue Date</b>	2016/03



### ■ Features

- ✓ White COB LED (19\*19\*1.5mm)
- ✓ Hot color targeting to 3 step ANSI eclipse bin
- ✓ 2700K,3000K,3500K,4000K,5000K,6500K CCT available
- ✓ Dice Technology : InGaN
- ✓ Environmental friendly ; RoHS compliance

### ■ Applications

- ✓ General lighting
- ✓ Indoor and outdoor commercial lighting
- ✓ PAR lamp, Downlight, etc.

# Outline Dimension

## PB19H01.0 Product Specification

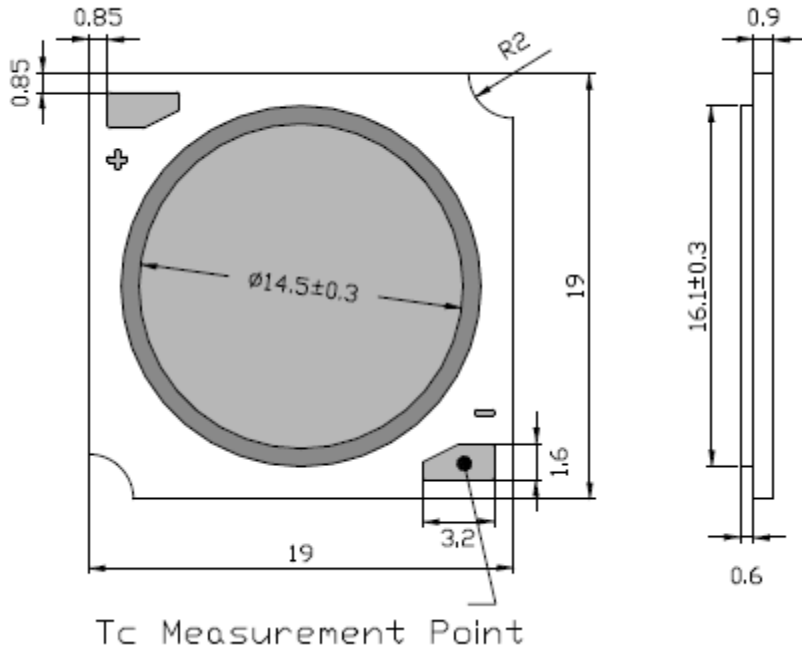

Unit: mm

Tolerances unless otherwise specified:  $\pm 0.2$ mm

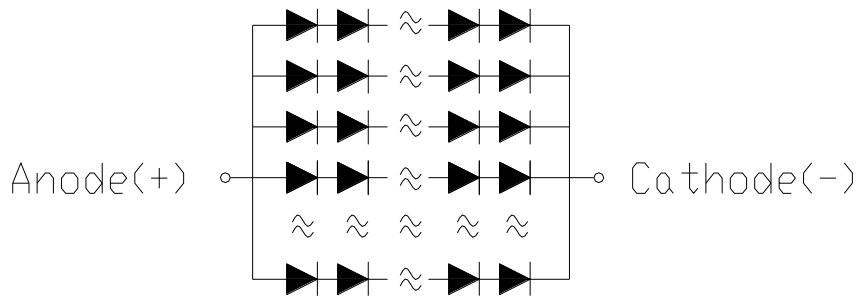

Note: Circuit layout is 6 series and 7 parallel

Performance

PB19H01.0 Product Specification

**Electro-Optical Characteristics (I<sub>F</sub>=540mA)**

CCT	Luminous flux (lm)		CRI		Voltage ( V )			Thermal Resistance (°C/ W)	View Angle (deg)
	T <sub>j</sub> =85°	T <sub>c</sub> =25°*	R <sub>a</sub>	R <sub>9</sub>	Min.	Typ.	Max.		
	Typ.	Typ.	Min.	Min.					
2700K	2,506	2,769	80	0	30.7	33.4	36.1	0.59	120
3000K	2,627	2,903							
3500K	2,688	2,970							
4000K	2,743	3,031							
5000K	2,768	3,058							
6500K	2,743	3,031							

1. Lextar Electronics maintains a tolerance of ±3% on forward voltage ,±7% on luminous flux , ±2 on Ra and R9.

\*Values of Luminous flux at T<sub>c</sub>=25°C are provided as reference only.

**Absolute Maximum Ratings**

Parameter	Symbol	Value	Unit
DC Forward Current <sup>(1)</sup>	I <sub>F</sub>	1350	mA
Power Dissipation	P <sub>d</sub>	49.4	W
Storage Temperature	T <sub>c</sub>	-40 ~ 100	°C
Junction Temperature	T <sub>J</sub>	130	°C
Cast Temperature	T <sub>sub</sub>	100	°C
Manual Soldering Time at 300 °C(Max)	T <sub>sol</sub>	3.5	sec

1. Please refer to the operating limit sections.

■ Chromaticity Coordinates (Extrapolated to Tc= 85°C)

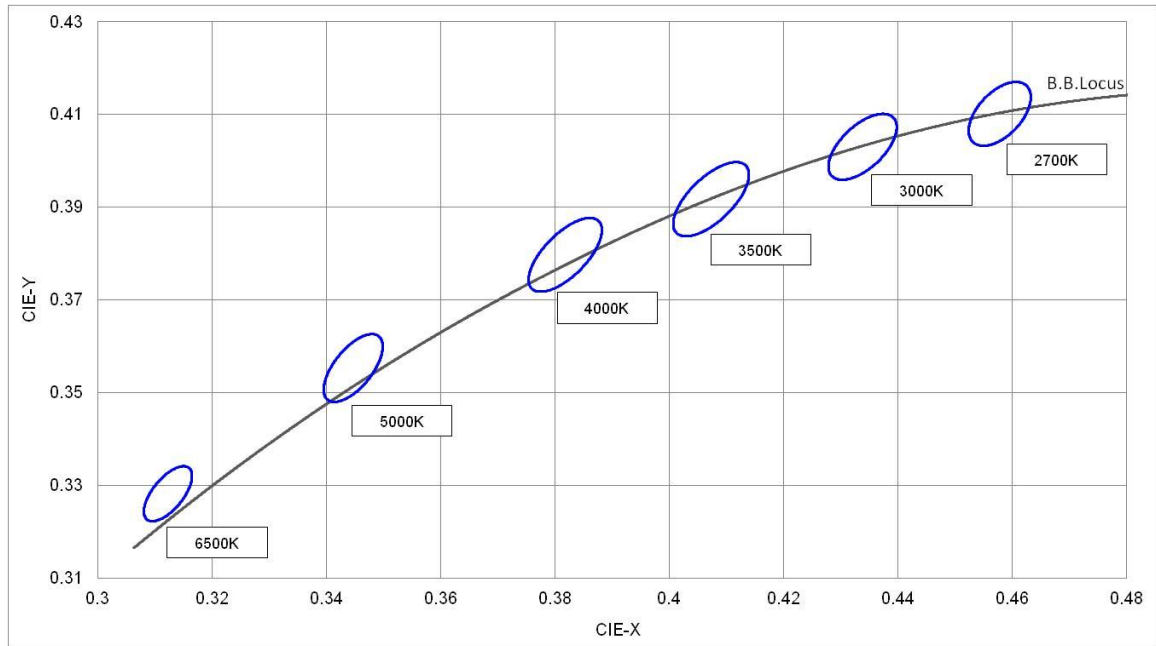

3-Step	2700K (273)	3000K (303)	3500K (353)	4000K (403)	5000K (503)	6500K (653)
Center Point, Cx	0.4578	0.4338	0.4073	0.3818	0.3447	0.3123
Center Point, Cy	0.4101	0.4030	0.3917	0.3797	0.3553	0.3282
Major Axis, a	0.00774	0.00834	0.00951	0.00939	0.00822	0.00669
Minor Axis, b	0.00411	0.00408	0.00417	0.00402	0.00354	0.00285
Rotation Angle	57.28	53.17	52.97	54.00	59.62	58.57

1. Tolerance of measurement is Chromaticity (x,y)  $\pm$  0.005.

■ **Binning (IF=540mA)**

CCT	Step	CRI	Flux	Voltage
27	3	A	U1	DB

CCT Bin Code	CCT
273	2700K-3step
303	3000K-3step
353	3500K-3step
403	4000K-3step
503	5000K-3step
653	6500K-3step

CRI Bin Code	CRI	R9
A	> 80	> 0

Flux Bin Code	Tc=85°C	
	Min	Max
S5	2318	2430
T1	2430	2576
T2	2576	2722
T3	2722	2868
T4	2868	3014

Voltage Bin Code	Tc=85 °C		Tc=25 °C	
	Min	Max	Min	Max
DB	30.7	36.1	32.0	37.6

1. Correlated color Temperature is derived from the CIE 1931Chromaticity diagram.
2. Lextar Electronics maintains a tolerance of  $\pm 3\%$  on forward voltage ,  $\pm 7\%$  on luminous flux ,  $\pm 2$  on CRI and R9.

### ■ Spectrum

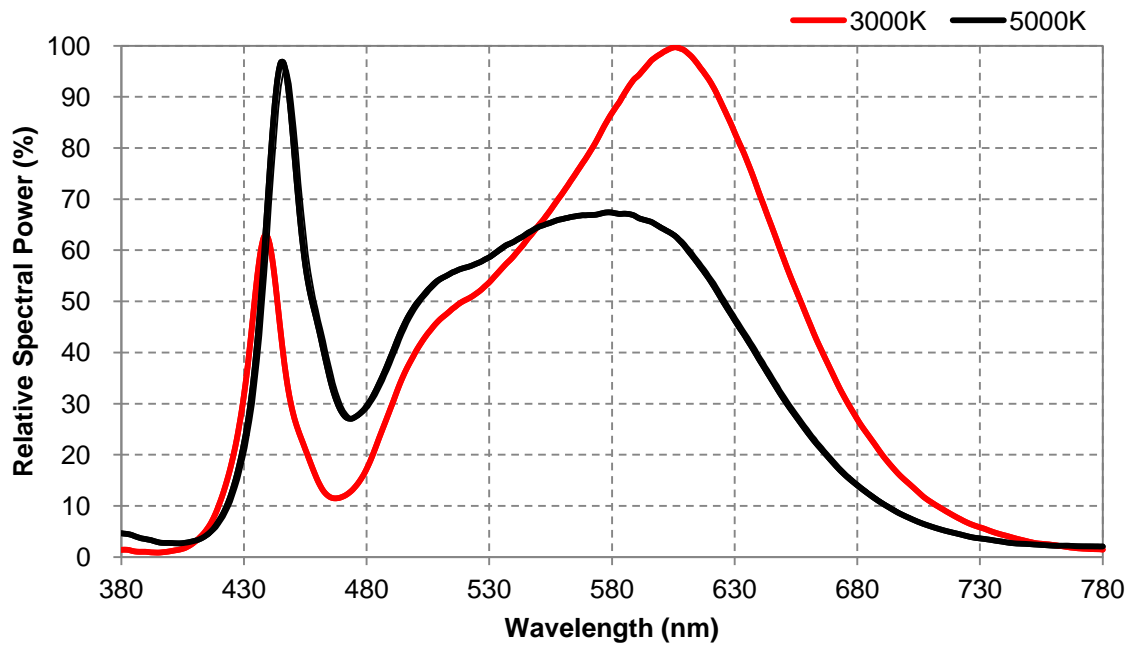

### ■ Radiation Pattern ( $I_F=540mA$ )

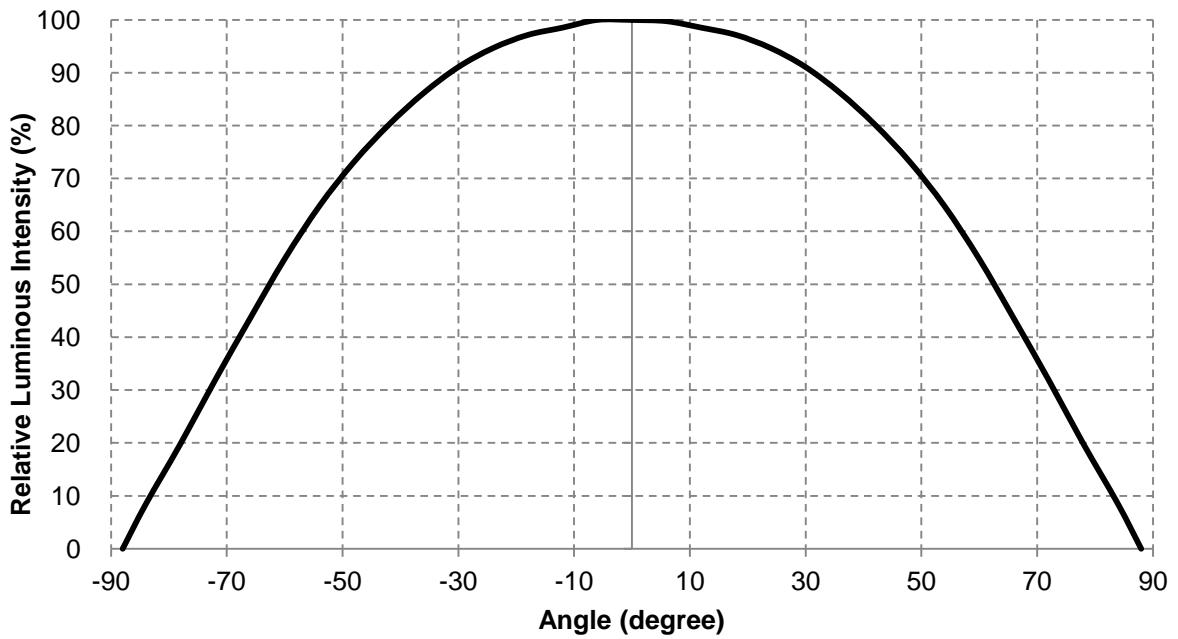

■ **Forward Voltage vs. Forward Current (Tc=85°C)**

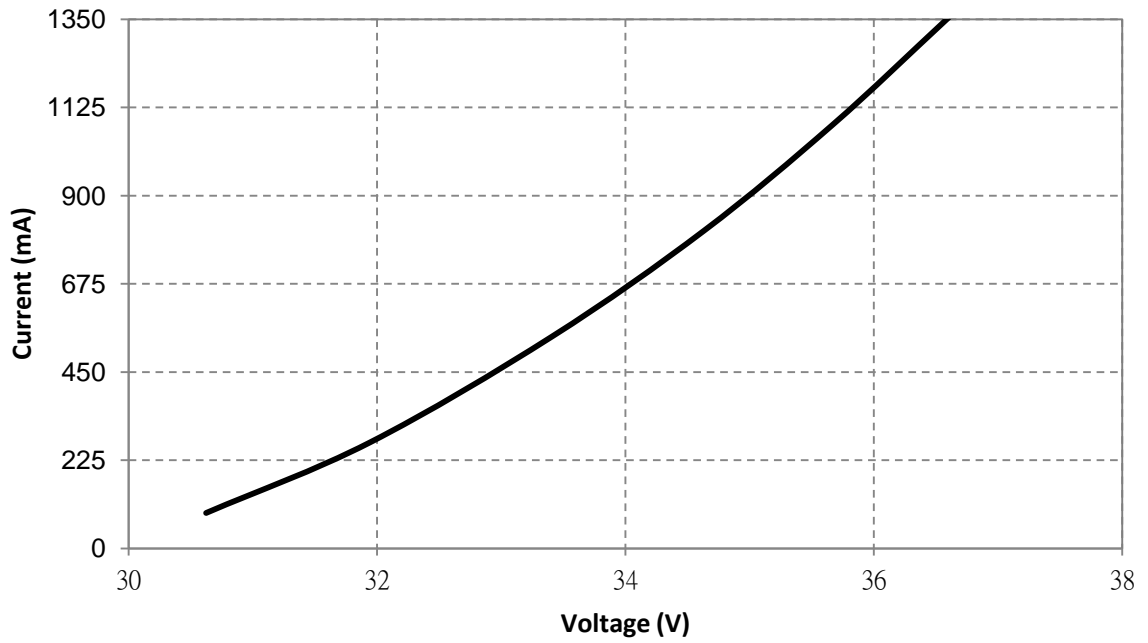

■ **Forward Current vs. Related Luminous Flux**

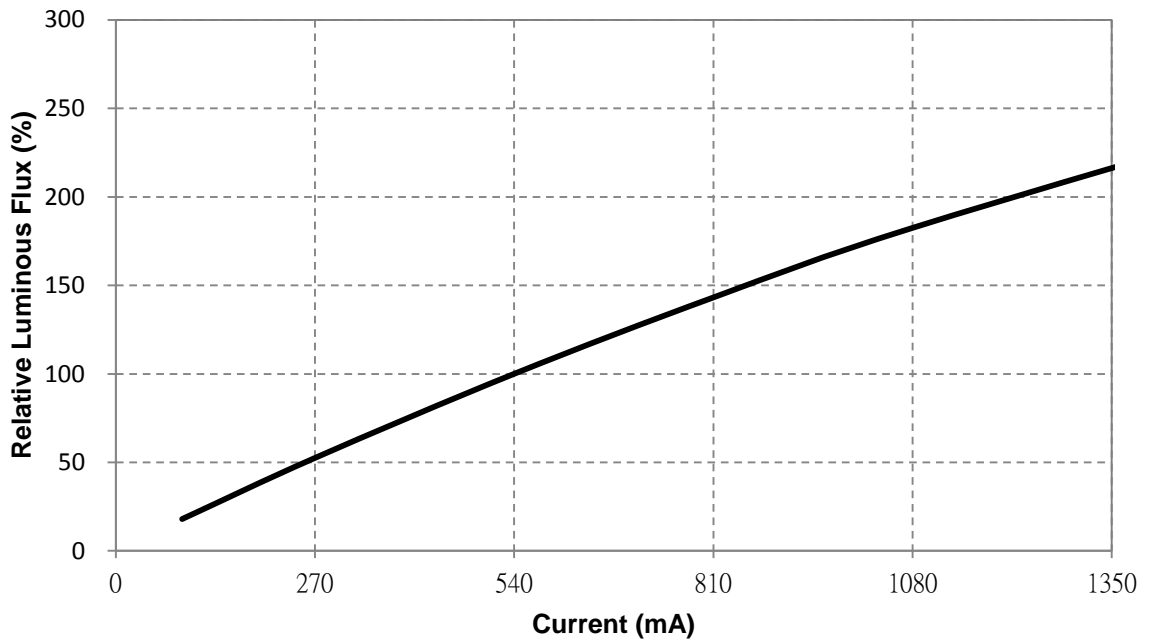



■ **Forward Current vs. Chromaticity Coordinate**

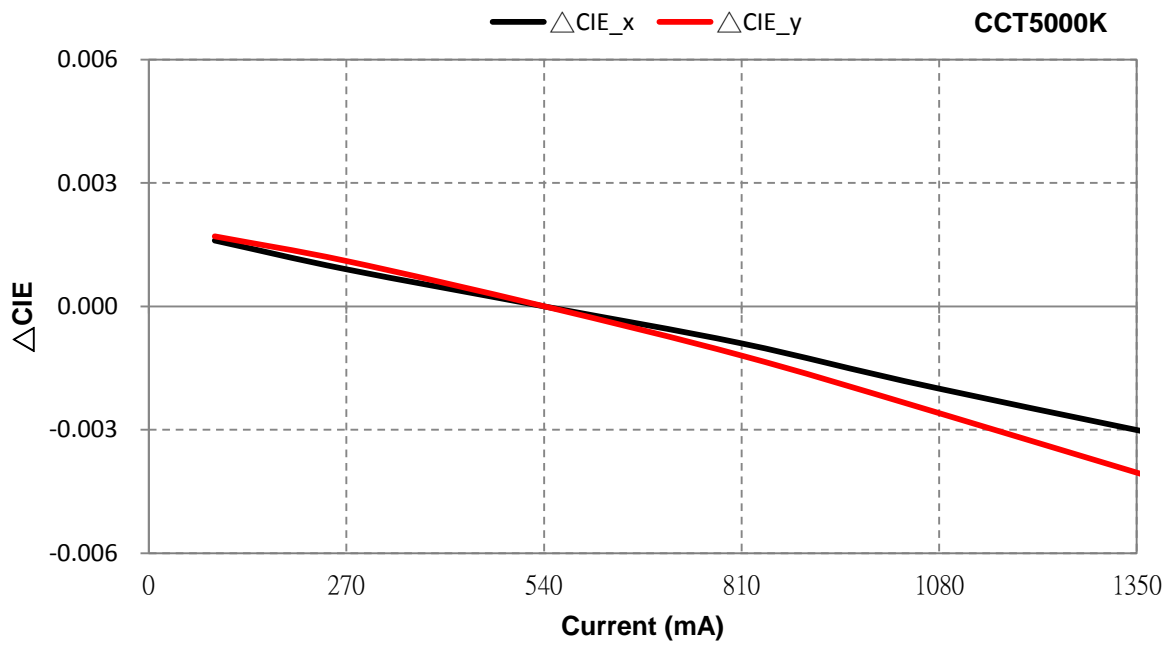
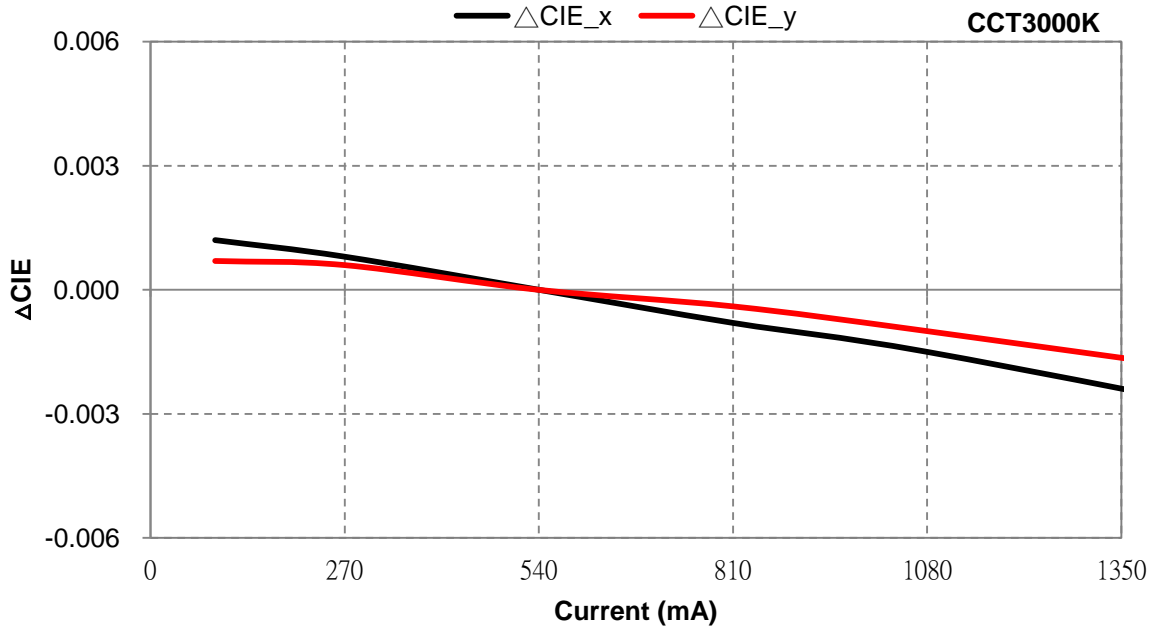

■ **Cast Temperature vs. Forward Voltage ( $I_F=540\text{mA}$ )**

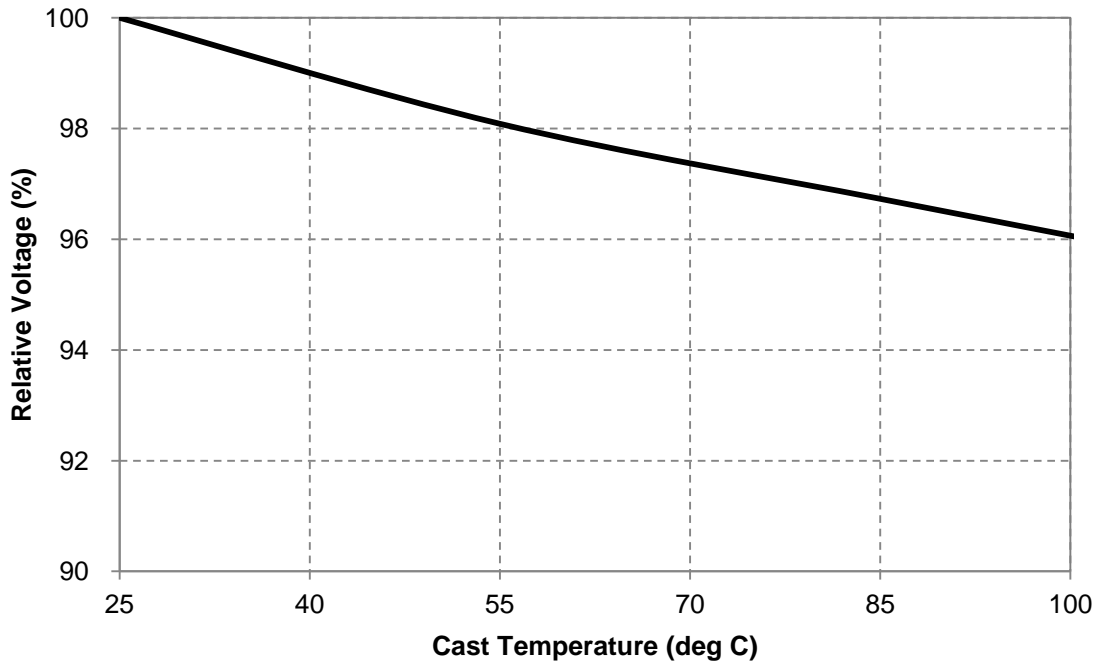

■ **Cast Temperature vs. Relative Luminous Flux ( $I_F=540\text{mA}$ )**

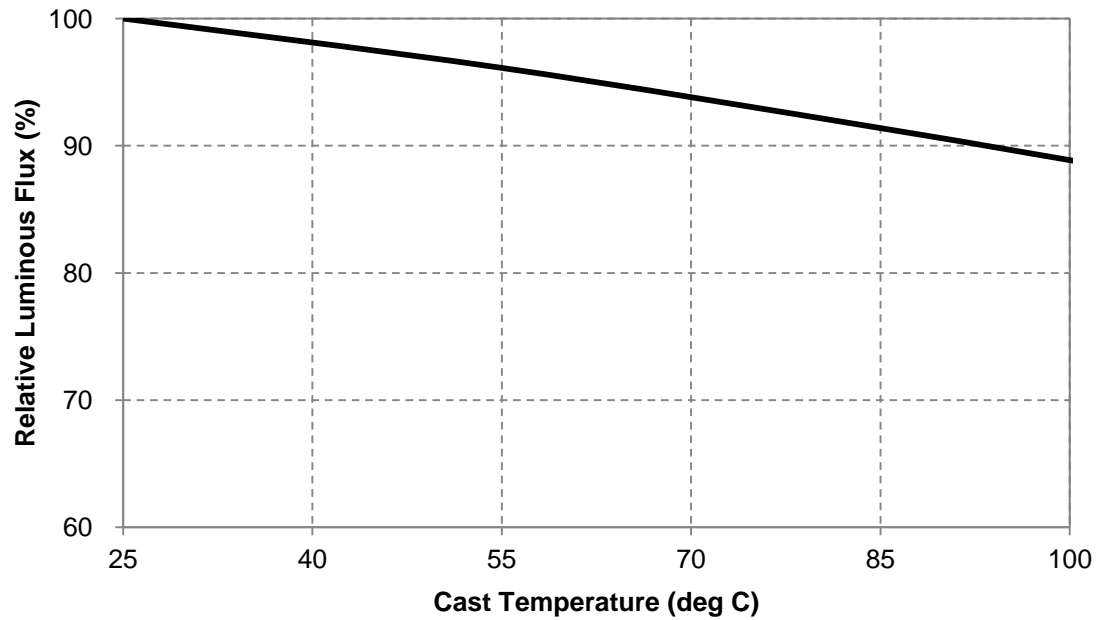

■ **Cast Temperature vs. Chromaticity Coordinate ( $I_f=540mA$ )**

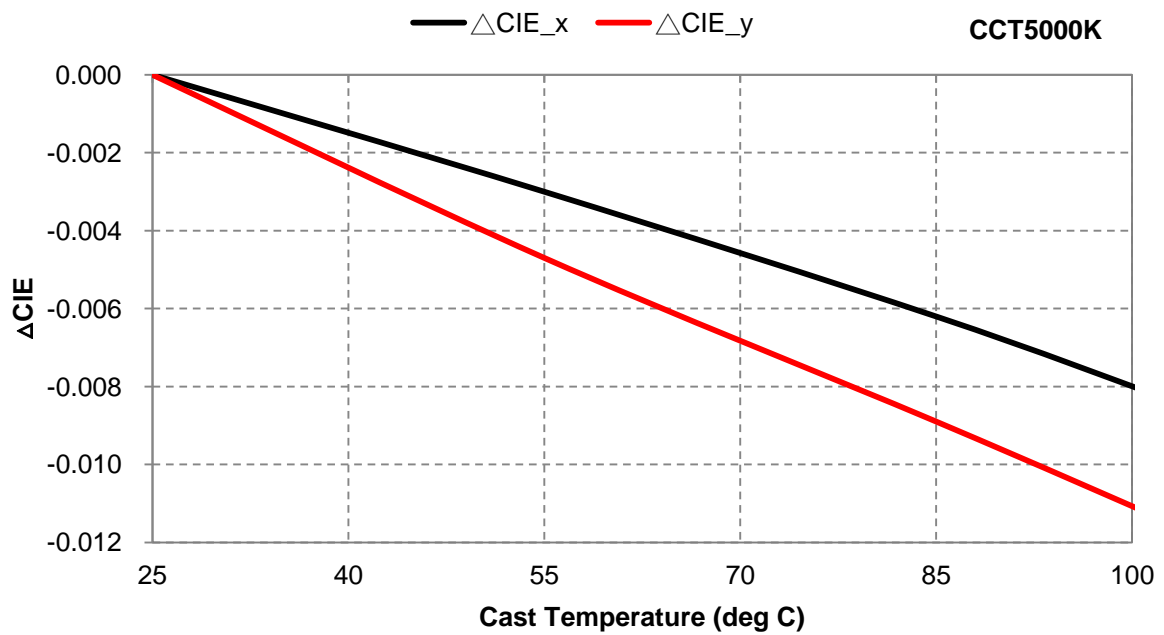
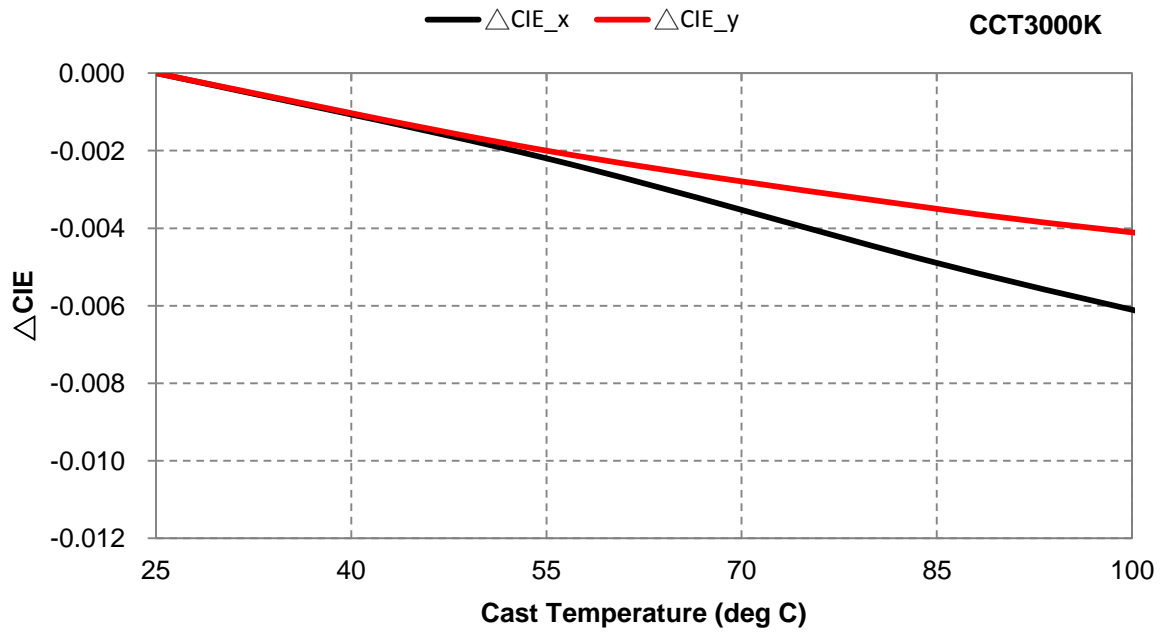

■ **Derating Characteristics**

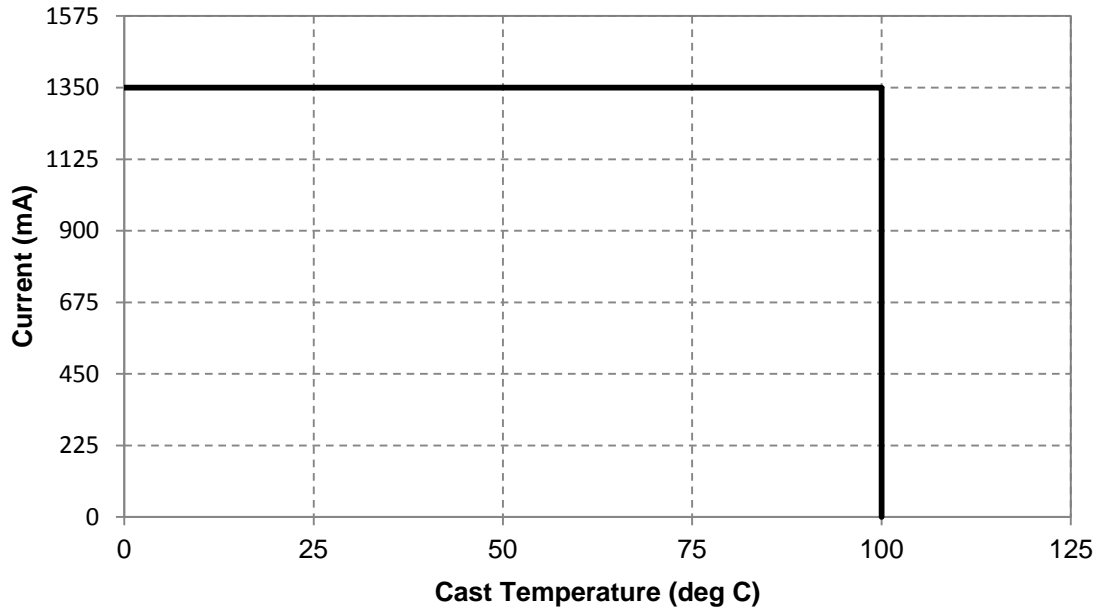

**Reliability**

PB19H01.0 Product Specification

No	Item	Condition	Time/Cycle
1	High Temperature Operation Life Test	Tc= 85°C	1000 Hrs
2	Low Temperature Operation Life Test	Ta= -40°C	1000 Hrs
3	High Temperature and High Humidity Operation Life Test	Tc= 85°C, 85%RH	1000 Hrs
4	High Temperature Storage	Ta= 100°C	1000 Hrs
5	Low Temperature Storage	Ta= -40°C	1000 Hrs
6	High Temperature High Humidity Storage	Ta= 85°C, 85 % RH	1000 Hrs
7	Temperature Cycle Storage	-40°C~100°C (20min dwell) /5min transfer	300 Cycles

**Judgment Criteria**

Item	Symbol	Judgment Criteria
Forward Voltage	$V_F$	$\Delta V_F < 10 \%$
Luminous Flux	$I_v$	Decay $\leq 20 \%$

# Packing

PB19H01.0 Product Specification

## Tray

One tray composed of maximum 42 pieces COB.

One inner box contains maximum 10 trays (420 pieces) and one upper lid-tray in one anti static bag

<One tray>

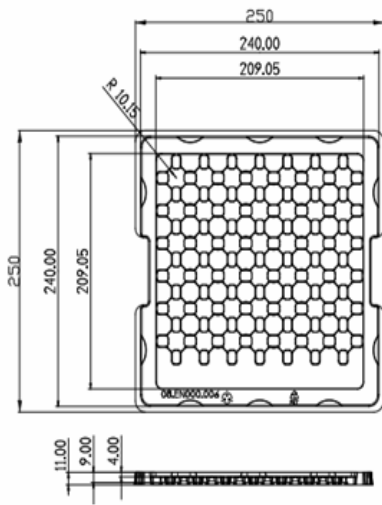

< One inner box >

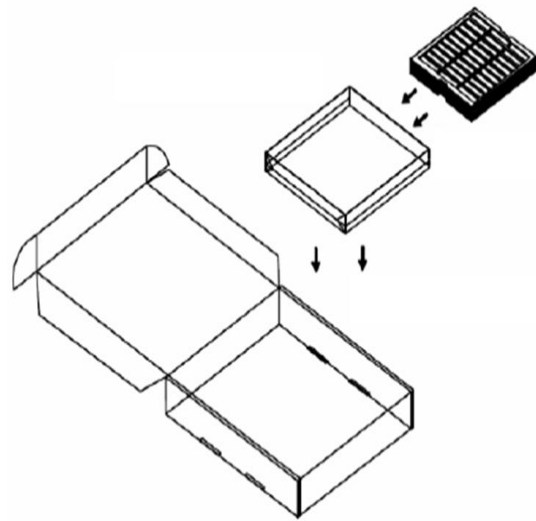

## Label information



WO : Working number  
 EQP ID : Equipment ID  
 P/N : Part number



SHIP ID : Shipment IS  
 BIN CODE : BIN CODE  
 M/N : Model Name  
 QTY : Quantity

## Precautions

PB19H01.0 Product Specification

1. Avoid the application of any stress to the resin portion (lighting area).
2. Avoid any contact by a sharp metal nail or other materials with the resin portion (lighting area).



3. This product should be secured firmly by fastening screws on both sides of the product. Please be careful not to apply any stress to the product during the clamping operation.



4. For fixing this product to the outer heat sink, thermal pad or thermal glue should be applied between backside of substrate and heat sink so that the product can dissipate heat completely. Please avoid product deformation when fixing the clamping operation.
5. Handling of static electricity
  - These products are sensitive to static electricity charge. Please prevent any static electricity within the assembling process.
  - All devices, equipment and machinery must be properly grounded. It is recommended that precautions be taken against surge voltage to the equipment that mounts the LEDs.
  - ESD sensitivity of this product is 1000V (HBM, based on JEITA ED-4701/304).
  - It is easy to find static-damaged LEDs by a light-on test.
6. Before open the package, should kept at room temperature, 90% RH environment or less. The LED should be used within 6 months.
7. After open the package, the LED should be kept at room temperature, 60% RH environment or less. The LED should be soldered within 168 hours (7 days) after opening the package. If unused LEDs remain, they should be stored in moisture proof packages, such as sealed containers with packages of moisture absorbent material (silica gel).
8. Applying proper resistor for the circuit design is recommended. Otherwise slight voltage shift may cause big current change and the LED may be burn out.
9. Please ensure that heat and electronic generation is not in excess of the absolute maximum rating.

## Revision History

PB19H01.0 Product Specification

Date	Contents	Writer
2016.03.05	Datasheet Initial	Chin Lin
2016.03.31	Update flux bin definitions	Chin Lin

Lextar Electronics Corp. reserves the right to modify the technical information or data without notification when product is improved.

## *Smart Lighting* *Amazing Life*

Lextar Electronics Corp. is the leading LED (Light Emitting Diode) maker integrating upper stream epitaxial, middle stream chip, and downstream package, SMT and LED lighting applications. Founded in May, 2008, Lextar is a subsidiary of AU Optronics, the leading TFT-LCD and solar PV manufacturer. Lextar's product applications include lighting and LCD backlight. Lextar's manufacturing sites include Hsinchu and Chunan in Taiwan, and Suzhou in China.

The company turnover in 2010 is 266 million USD.